



# UV-AIRE™ AIR PURIFYING SYSTEM

Model: UV-12,18



## ITEMS INCLUDED IN KIT:

- 1-UV-Aire™ power unit
- 4-Sheet metal mounting screws
- 1-Angled mounting bracket
- 1-Flat mounting bracket
- 1-Duct board mounting bracket
- 1-Ultra Violet lamp
- 1-Instruction Sheet
- 1-Wing nut
- Caution Labels
- Gasket

UV-C light inhibits the growth and reproduction of germs and bacteria that circulate through a homes' heating and air conditioning system. The treatment is a safe, silent, and proven way to make your home a healthier place to live.

## READ THESE INSTRUCTIONS CAREFULLY AND COMPLETELY BEFORE PROCEEDING WITH THE INSTALLATION

LEAVE THE INSTALLATION INSTRUCTIONS WITH THE OWNER/OPERATOR OF THE DEVICE

AFTER OPENING THE CARTON, UNPACK AND INSPECT THE UNIT AND LAMP FOR DAMAGE.

**DO NOT** INSTALL THIS UNIT IF ANY DAMAGE IS NOTICEABLE.

## SAFETY CONSIDERATIONS



**WARNING:** *Never expose eyes or skin to UVC light from any source.*

- Looking directly at the UVC light may cause permanent eye damage or blindness.
- **Never operate the UV-Aire™ Air Purifying System out of the plenum.**
- Designed for a closed duct system. Do not mount near a supply or a return air opening
- All duct openings in direct line of site of the UV light must be sealed with aluminum duct tape or equivalent sealing methods.



**WARNING:** *UV light will break down plastic materials not rated for UV exposure:*

*(Examples: wire insulation, flex duct, drain pans and humidifiers)*

- The unit must be mounted at least 30" from the above stated type of materials.
- If it is necessary to mount the unit in direct line of site of these types of materials, they must be shielded with aluminum foil, aluminum foil tape, or sheet metal.



**WARNING:** *DO NOT mount this unit outdoors.*

- This product is designed for indoor installation only (i.e. attics, crawl spaces, basements, etc.).



**FIELDCONTROLS**  
SOLUTIONS FOR THE GREAT INDOORS™

2630 Airport Road • Kinston, NC 28504  
Phone: 252-522-3031 • FAX: 252-522-0214  
[www.fieldcontrols.com](http://www.fieldcontrols.com)

## I. INDICATION FOR USE

This product is not sold as a medical device and is not for the purpose of diagnosis of any disease or condition nor for use in the mitigation, treatment, or prevention of any disease or condition.

## II. GENERAL INFORMATION

There are different size units available, depending on the square footage of your home. See chart below for determining your homes needs.

Model	Minimum Duct Width	Volts	Amps	Hz	Watts	Max Air Temp °F	Lamp Intensity at 1 meter	Recommended Max Sq. Feet
UV-12	9	120	0.5	60	30	190°	37 $\mu\text{W}/\text{cm}^2$	1500
UV-18	14	120	0.5	60	30	190°	73 $\mu\text{W}/\text{cm}^2$	2000



**WARNING:** Before installing or servicing a humidifier, air filter, heat system, or this unit, etc., always turn all power OFF and have unit unplugged. Electrical shock can cause personal injury or death. Never expose eyes or skin to direct UVC light from any source.



**WARNING:** To prevent water damage or electric shock, do not mount unit under a humidifier.



**WARNING:** Designed for a closed duct system. Do not mount near a supply or a return air opening.



**WARNING:** This product is designed for indoor installation only (i.e. attics, crawl spaces, basements, etc.). For use on gas fired, oil fired, electric and split system heat pump forced air systems\*. This product is NOT designed to be mounted outside on gas fired or heat pump packaged units\*\*.

\*Split system heat pumps are systems where the air handler and the air conditioning compressor are separate units.

\*\*Packaged units are systems where the air handler and the air conditioning compressor are built together and are installed outside of the building

## III. INSTALLATION

1. Locate a suitable location for the unit downstream from the 'A' coil in the supply plenum or in the return plenum; preferably downstream from the air filter. For optimum "cleaning" effect on the 'A' coil, mount the unit in the supply plenum as close as possible to the 'A' coil. (See Figure 1)

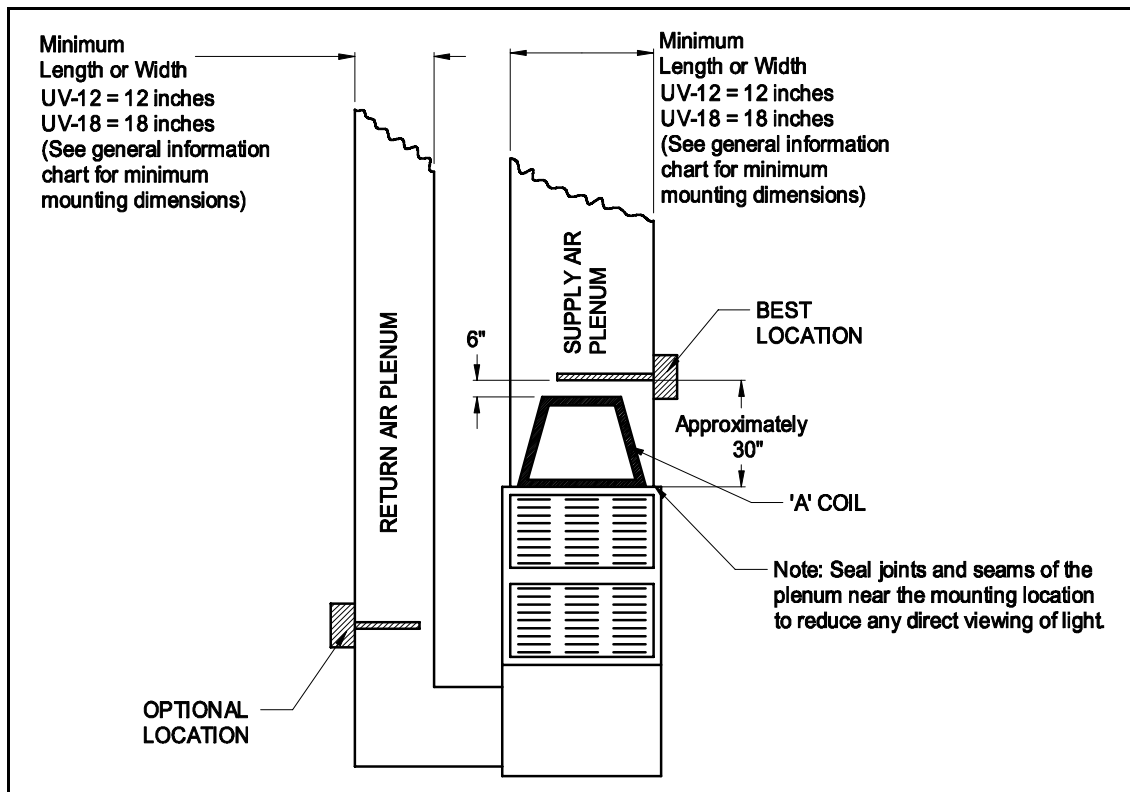

Figure 1



**WARNING:** Never expose eyes or skin to UVC light from any source. Looking directly at the UVC light may cause permanent eye damage or blindness. Never operate the UV-Aire™ Air Purifying System out of the plenum. Avoid touching the glass portion of the lamp with your hands.

2. Determine the type of duct you have.  
(For flex duct applications, refer to Figure 21 on page 8)

**IF YOU HAVE METAL DUCT:**

- Apply supplied wet and stick mounting template to air duct in either a vertical or horizontal position as shown in Figure 2.
- Drill 1/8" diameter mounting holes at positions indicated on template.
- Cut out the marked openings on template using a hole saw or a pair of tin snips or jigsaw. (See Figure 2)
- Remove paper template from duct.

**IF YOU HAVE DUCT BOARD:**

- Mount the supplied metal mounting plate onto the duct with duct tape in either a vertical or horizontal position as shown in Figure 2. (See Figure 3)
- Bend tabs outward as shown in figure 4.
- Using a knife or blade, cut out a rectangle opening in the duct using the mounting plate as a template. (See Figure 5)
- Remove the cut piece of duct. (See Figure 6)
- Bend both tabs down and through duct at first bend point. (See Figures 7 & 8)
- Bend both tabs at the second bend point up or down to pinch the duct material and grip the duct material. (See Figures 9 & 10)
- Using a screwdriver or pointed object, locate mounting holes by poking holes through the duct tape. (See Figure 11)

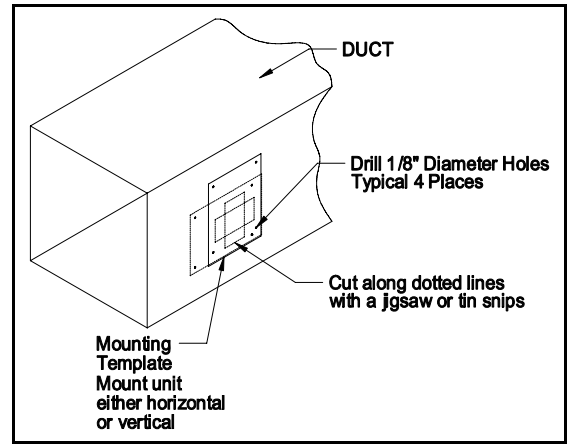

Figure 2



Figure 3



Figure 4



Figure 5

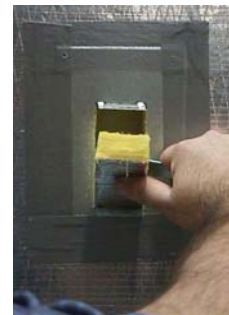

Figure 6



Figure 7



Figure 8



Figure 9



Figure 10



Figure 11



**WARNING:** Never expose eyes or skin to UVC light from any source. Looking directly at the UVC light may cause permanent eye damage or blindness. Never operate the UV-Aire™ Air Purifying System out of the plenum. Avoid touching the glass portion of the lamp with your hands.

3. Remove base unit and cover from box.
4. Apply supplied “Duct Seal Kit” according to instructions included in kit (See Figure 12)



Figure 12

5. Determine whether to use flat or angled bracket. (Refer to UV-Aire “Bulb Mounting Bracket Selection” in section IV for aid in this decision)

a. Flat Bracket Installation

- i. Remove the two hex nuts and flat bracket from included bagged hardware.
- ii. Install the flat bracket and secure to the unit base with the hex nuts provided. (See Figure 13)



Figure 13

b. Angled Bracket Installation

**NOTE:** For angled bracket mounting, refer to specifications outlined by Diagrams A & B for mounting distances in the “Angled Lamp Mounting Bracket Specifications” in section IV.

- i. Remove the two hex nuts and angled bracket from included bagged hardware.
- ii. Install the angled bracket and secure to the unit base with the hex nuts provided. (See Figure 14)

**NOTE:** Be sure to note location of lamp hole in bracket relative to unit base.



Figure 14

6. Mount the unit base to the duct using the four mounting screws provided. (See Figure 15)
7. Remove tag and alcohol wipe from lamp. Wipe off lamp being sure not to touch lamp with bare hands. The oils from your hands will reduce lamp output.



Figure 15

8. Insert lamp through hole until lamp cannot be inserted any further. (See Figure 16)



Figure 16

9. Swing the swivel bracket over end of lamp. Hand-tighten the wing nut on stud. (See Figure 17) Be careful not to over tighten the wing nut. The porcelain at the lamp base may crack when over tightened.



Figure 17

10. Plug ballast plug into end of lamp. (See Figure 18)



Figure 18

11. Snap cover onto the unit base. Close the cover and tighten cover screw. (See Figure 19 & 20)

12. Plug the power cord into a standard electrical outlet.

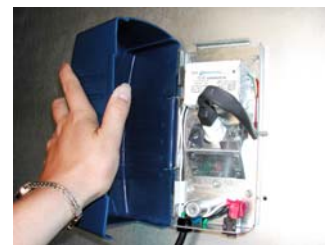

Figure 19



Figure 20

**NOTE:** Seal the joints and seams of the plenum near the mounting location to reduce any direct viewing of light. (See Figure 1)

13. Press the power switch to the 'ON' position. (Light on switch should be on indicating power.)

14. Look through view port in the box cover to be sure lamp is working. You should see a blue glow. (The view port is covered with a plastic lens that blocks the UVC rays.)

15. If the lamp is not glowing, follow steps 8-14 again. If lamp still does not glow, contact technical support at 1-252-522-3031 for further assistance.



**WARNING:** Never expose eyes or skin to UVC light from any source. Looking directly at the UVC light may cause permanent eye damage or blindness. Never operate the UV-Aire™ Air Purifying System out of the plenum. Avoid touching the glass portion of the lamp with your hands.

#### IV. BULB MOUNTING BRACKET SELECTION

The UV-AIRE™ units come with an angled mounting bracket and flat mounting bracket to position the bulb either straight or at an angle. Choose one or the other bracket method best suited for your needs. Refer to the configurations chart below when making your selection.

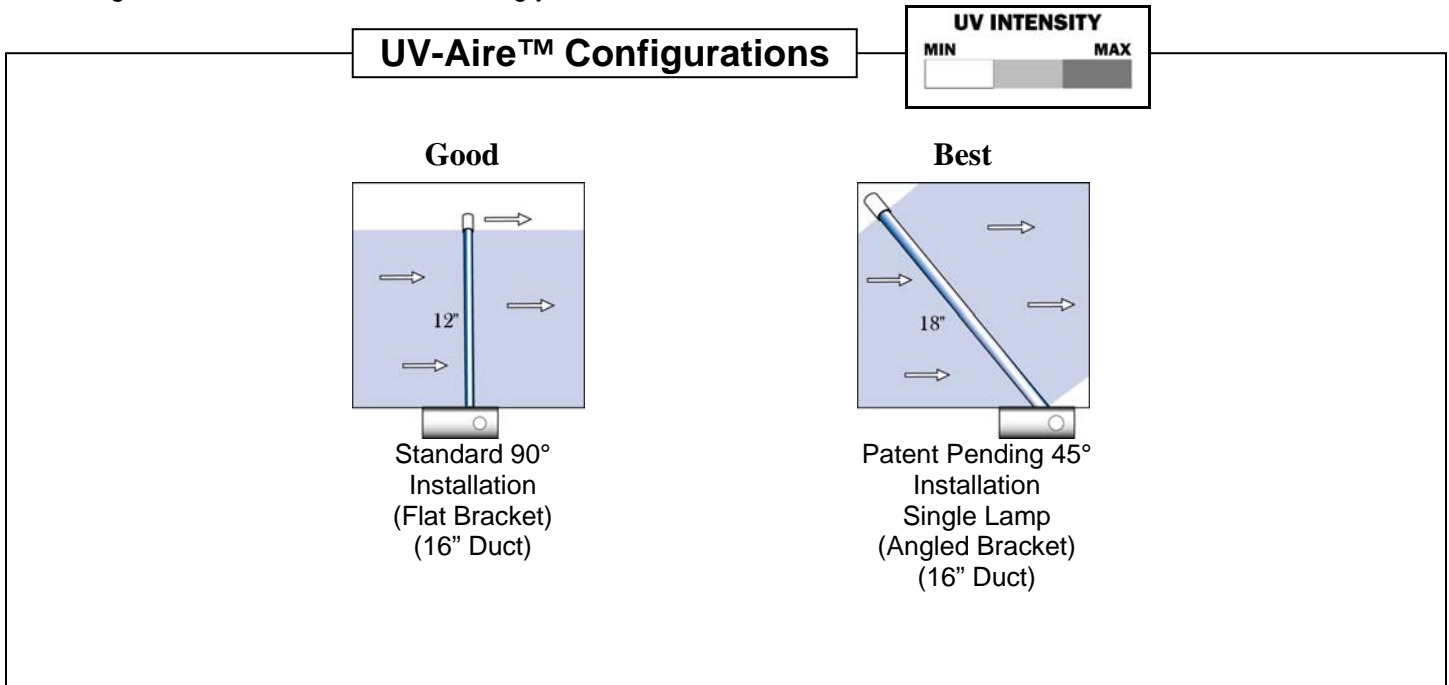

#### ANGLED LAMP MOUNTING BRACKET SPECIFICATIONS

Use the specifications below to determine allowable clearances for proper mounting of the UV-Aire™ unit on the duct.

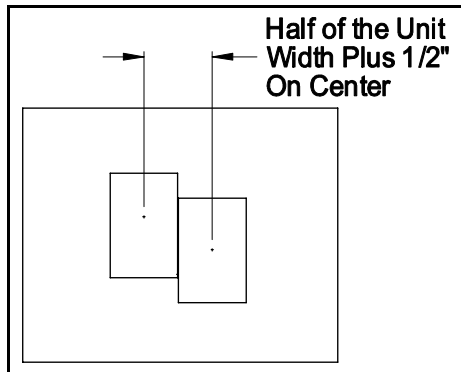

Chart A

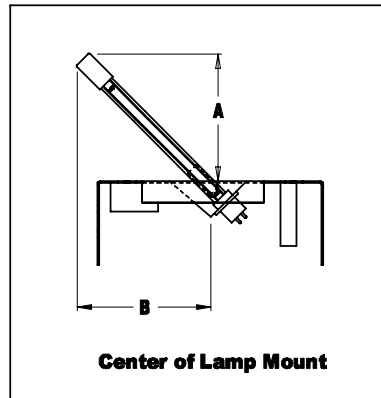

Chart B

LAMP OFFSET DIMENSIONS			
Unit	Min Duct Size (inches)	A	B
UV-12	9x12	8-1/2	6-1/2
UV-18	14x18	13-1/2	10-5/16

**WARNING:** Never expose eyes or skin to UVC light from any source. Looking directly at the UVC light may cause permanent eye damage or blindness. **Never operate the UV-Aire™ Air Purifying System out of the plenum.** Avoid touching the glass portion of the lamp with your hands.

## V. MAINTENANCE

1. Inspect and clean lamp at least every 6 months.
2. Replace your UV-Aire™ Air Purifying System lamp once a year to maintain the lamps maximum output intensity. The lamp should operate continuously for maximum lamp life and light effectiveness.

## VI. LAMP REPLACEMENT PROCEDURE



**VERY IMPORTANT:** Turn switch on unit to 'OFF' position and unplug unit from outlet.

1. Loosen the cover screw on the side of the unit and open cover.
2. Unplug ballast plug from end of lamp.
3. Loosen the wing nut on swivel bracket and rotate the bracket clockwise.
4. Slide lamp out carefully.

**NOTE:** When replacing the lamp, always wipe off lamp before installing.

5. Insert the lamp through the mounting hole and secure the lamp by rotating the swivel bracket counter-clockwise into position and secure by tightening wing nut. Be careful not to over tighten the wing nut.

**NOTE:** UV lamps contain a small amount of mercury, like a typical fluorescent lamp. Check with your local waste management authority for local disposal or recycling requirements. According to the EPA's Universal Waste Rule, these types of lamps may be disposed of into household waste.

6. Attach the ballast plug onto the end of the lamp.
7. After replacing lamp, make sure a new *Lamp Replacement Label* (supplied with lamp replacement) is applied to the housing and dated with the date of installation.

## VII. TROUBLESHOOTING GUIDE

1. If the lamp does not light up, replace the lamp.
2. If the lamp still does not light up after replacing the lamp, replace ballast.

## VIII. REPLACEMENT PARTS LIST

<b>MODEL</b>	<b>LAMP</b> (Field Controls Part Number)	<b>BALLAST</b> (Field Controls Part Number)
UV-12	46365401	46365508
UV-18	46365402	46365509

For replacement parts, contact your local heating service company. Any questions, please contact Field Controls at:

☎Phone: 252-522-3031

☎Fax: 252-522-0214

✉Email: sales@fieldcontrols.com



**WARNING:** Never expose eyes or skin to UVC light from any source. Looking directly at the UVC light may cause permanent eye damage or blindness. Never operate the UV-Aire™ Air Purifying System out of the plenum. Avoid touching the glass portion of the lamp with your hands.

## IX. FLEX DUCT INSTALLATION

For installations on duct systems with a metallic main duct and flex duct branches, follow the instructions in figure 21 below.

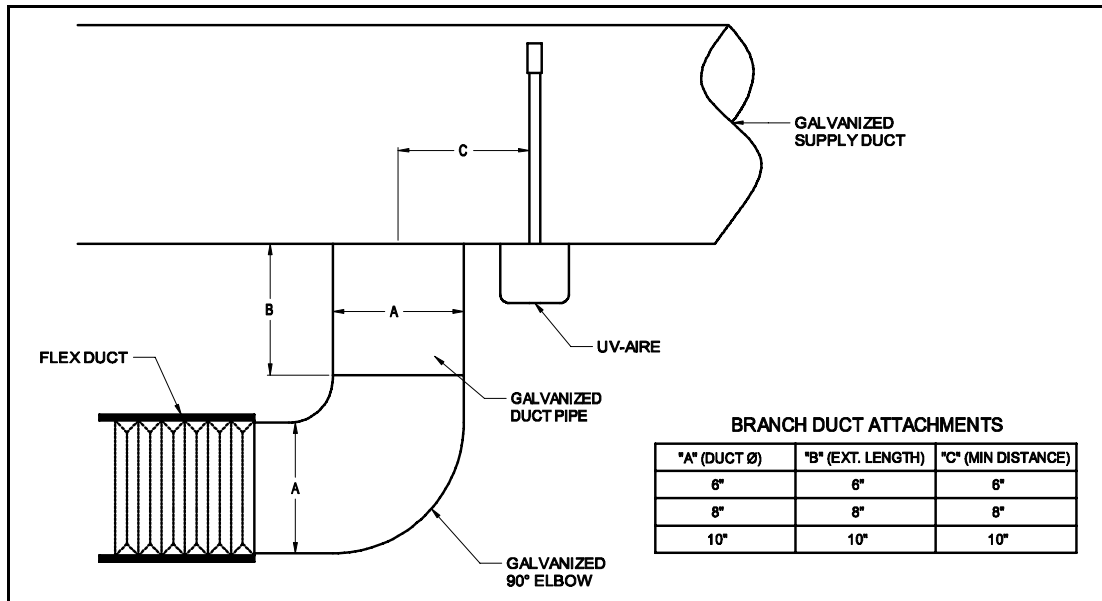

Figure 21

## Limited Warranty

Field Controls, L.L.C. warrants that the following Field Controls, L.L.C. products sold hereunder, shall be free from defects in material and workmanship under normal use for eighteen (18) months from date of manufacturing by the consumer excepting the provisions numbered below.

### UV-LAMPS/BULBS

Field Controls, L.L.C. warrants that the following Field Controls, L.L.C. products sold hereunder, shall be free from defects in material and workmanship under normal use for ninety (90) days from date of installation by the consumer excepting the provisions numbered below.

### Provisions:

1. Field Controls shall have no obligation in the event the customer is unable to provide receipt showing the date the customer purchased the product(s) or accurate date code information.
2. The product must be properly installed, maintained and operated under normal conditions.
3. Field Controls shall not be liable for any consequential and incidental damages, resulting from failure of a Field Controls, L.L.C. product, failure to deliver, delay in delivery, delivery in nonconforming condition, or for any breach of contract or duty between Field Controls, L.L.C. and the customer.
4. Field Controls, L.L.C. products are often intended for use in specific applications. Field Controls, L.L.C. makes no warranty if a Field Controls, L.L.C. product is used in applications other than intended.
5. Field Controls, L.L.C. makes no warranty of any kind in regard to any other manufacturer's products distributed by Field Controls, L.L.C. Field Controls, L.L.C. will pass on all warranties made by the manufacturer and where possible, will expedite the claim on behalf of the customer, but ultimately, responsibility for disposition of the warranty claim lies with the manufacturer.

*The health aspects associated with the use of these products and their ability to aid in disinfecting of environmental air have not been investigated by UL.*

